

Part Number: PT374-21050

NOTE: Part number of this accessory may not be the same as the part number shown.

Kit Contents

Item #	Quantity Reqd.	Description
1	1	AD Mirror Assembly w/ Ambient Lighting
2	1	Hardware bag
3	1	Installation Manual

Special Chemicals	Notes
Cleaner	Household Windex

General Applicability

--

Hardware Bag Contents

Item #	Quantity Reqd.	Description
1	2	T-tap Connectors, Red 3M™
2	1	T-tap Connector, Blue 3M™
3	1	Wire Cover
4	1	EC Wire Harness
5	9	Foam Tape
6	7	Wire Ties, small
7	1	Operation Instruction Card
8	1	Wire Retaining Clip

Recommended Sequence of Application

Item #	Accessory
1	EC Mirror
2	TVIP
3	Satellite Receiver
4	Audio

*Mandatory

Vehicle Service Parts (may be required for reassembly)

Item #	Quantity Reqd.	Description
1		

Additional Items Required For Installation

Item #	Quantity Reqd.	Description
1		





Conflicts

Curtain Side Air Bag

Recommended Tools

Personal & Vehicle Protection	Notes
Blankets, Towels	
Special Tools	Notes
None	
Installation Tools	Notes
Screwdriver	Phillips #2
Ratchet	
Socket	10 mm
Torx Head Driver	T20
Pliers	Needle Nose
Nylon Panel Removal Tool	e.g. Panel Pry Tool #1 Toyota SST# 00002-06001-01
Slotted Nylon Removal Tool	A suitable tool can be obtained from: Plastic Factory (310) 532-8850
Dark Towel or Cloth	For Testing
Torque Wrench	36 lbf-inch

Legend

	STOP: Damage to the vehicle may occur. Do not proceed until process has been complied with.
	OPERATOR SAFETY: Use caution to avoid risk of injury.
	CAUTION: A process that must be carefully observed in order to reduce the risk of damage to the accessory/vehicle and to ensure a quality installation.
	TOOLS & EQUIPMENT: Used in Figures calls out the specific tools and equipment recommended for this process.

Care must be taken when installing this accessory to ensure damage does not occur to the vehicle. The installation of this accessory should follow approved guidelines to ensure a quality installation.

These guidelines can be found in the "Accessory Installation Practices" document.

This document covers such items as:-

- Vehicle Protection (use of covers and blankets, cleaning chemicals, etc.).
- Safety (eye protection, rechecking torque procedure, etc.).
- Vehicle Disassembly/Reassembly (panel removal, part storage, etc.).
- Electrical Component Disassembly/Reassembly (battery disconnection, connector removal, etc.).

Please see your Toyota dealer for a copy of this document.

1. Remove Battery Cable.

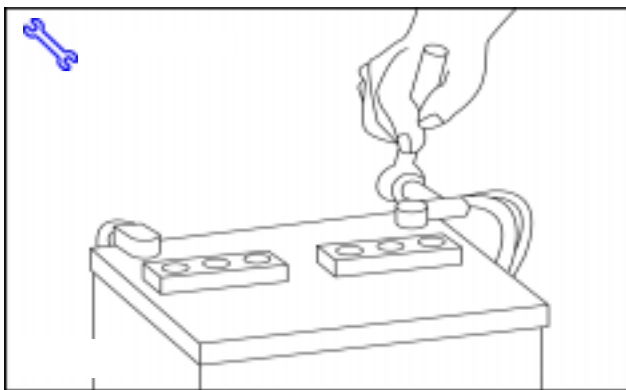

(a) Protect fender before starting.



(b) Do not touch the positive terminal with any tool when removing cable.

(c) Remove the negative battery cable. (Fig. 1-1)

2. Vehicle Disassembly.

(a) Remove OE mirror and discard.

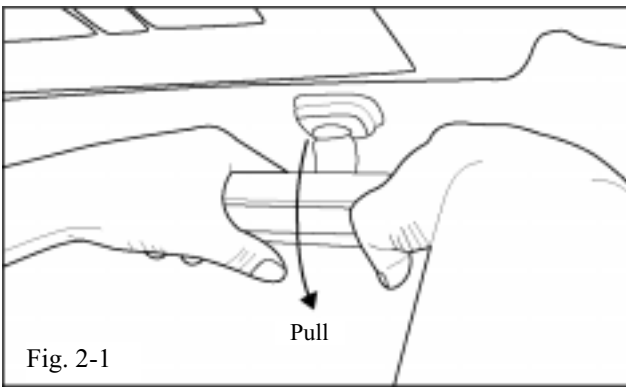

(1) With both hands, Grab Mirror firmly on both sides and pull downward sharply until mount releases from windshield button. (Fig. 2-1)

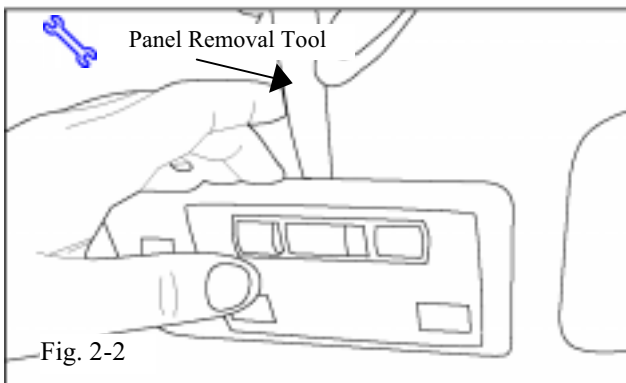

(b) With a panel removal tool, carefully remove the overhead dome light assembly. (Fig. 2-2)



(c) Take care not to damage headliner.

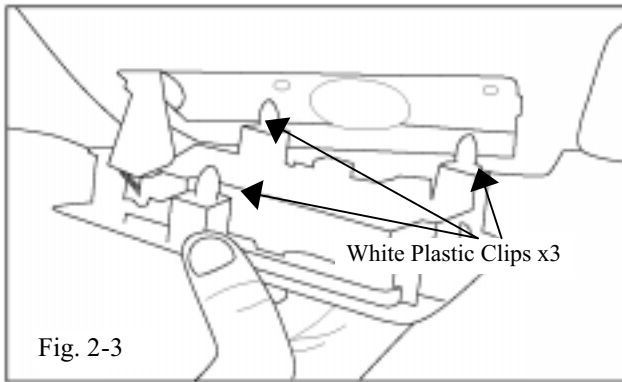

- (d) Pull downward to remove overhead console
NOTE: Ensure removal of all (3) white plastic clips. (Fig. 2-3)

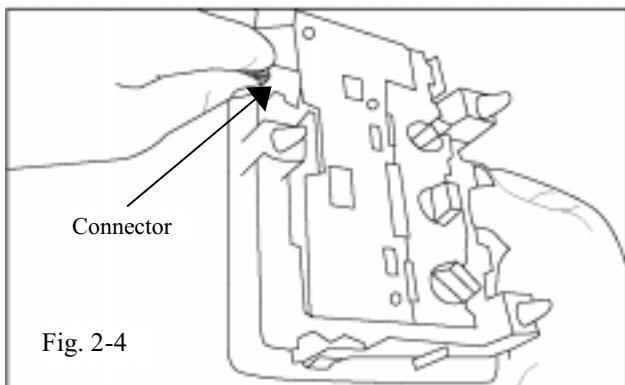

- (e) Carefully pull down the dome light assembly to expose the light connector. (Fig. 2-4)
(1) Disconnect the connector.

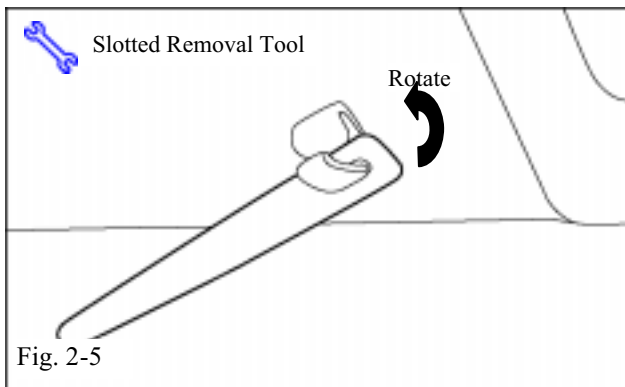

- (f) Using a slotted panel removal tool, loosen both driver side and passenger side sun visor clips by rotating clips 90 degrees counter clockwise. (Fig. 2-5)
(1) Rotating clips clockwise or more than 90 degrees (counter clockwise) will cause damage to clip when trying to remove it.
(2) Carefully pull clip with headliner down, taking care not to damage the clips. Do not remove clip from the headliner.

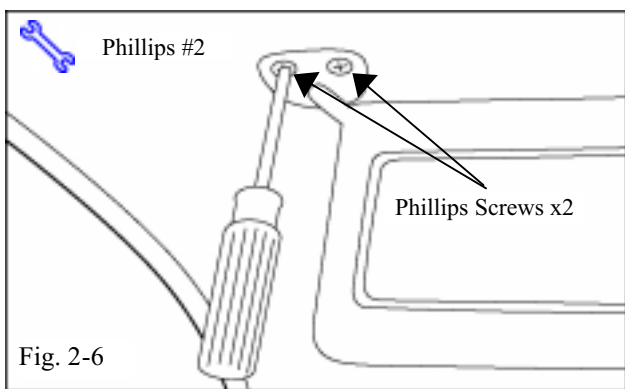

- (g) Remove two (2) screws from the driver side sun visor base. (Fig. 2-6)
(1) Remove sun visor.



- (h) Carefully remove "A" pillar by grabbing top of "A" pillar with hand and pull inwards toward center of vehicle. (Fig. 2-7)

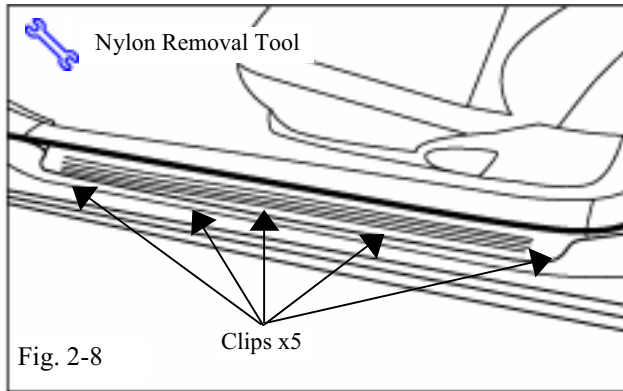

- (i) With panel removal tool remove driver side door scuff plate. (Fig. 2-8)
 - (1) Disconnect all five (5) clips on scuff plate before attempting to remove.

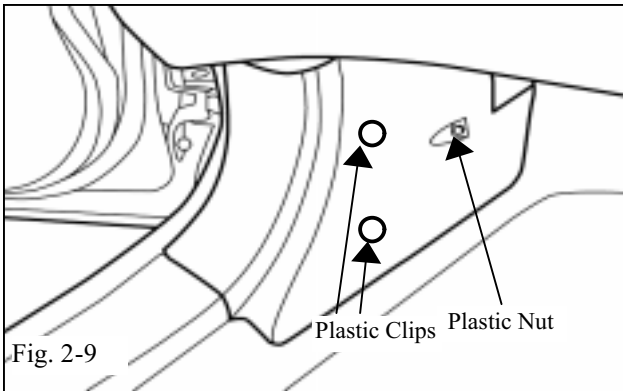

- (j) Remove driver side cowl cover. (Fig. 2-9)
 - (1) Remove plastic nut and disengage two (2) plastic clips.
 - (2) Ensure removal of two (2) white plastic clips (Fig. 2-9)

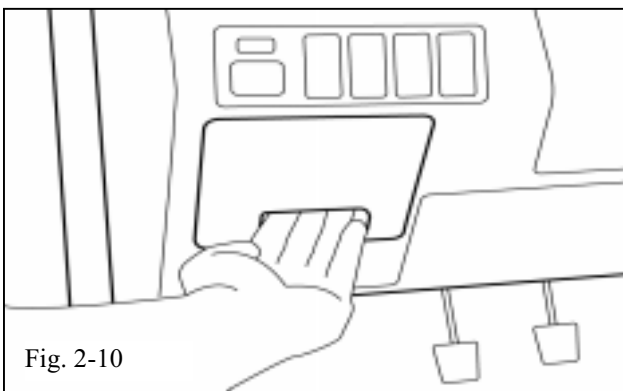

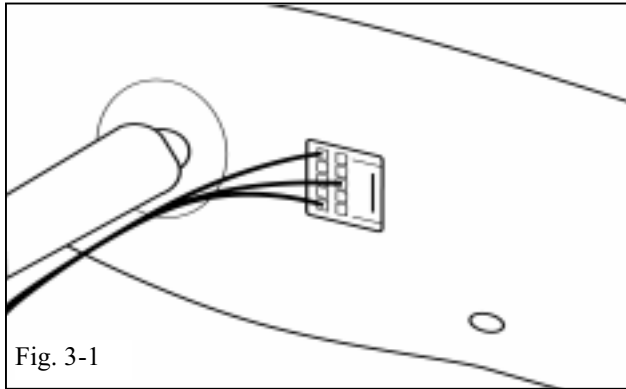

- (k) Remove fuse panel cover. (Fig. 2-10)

3. Mirror Installation.



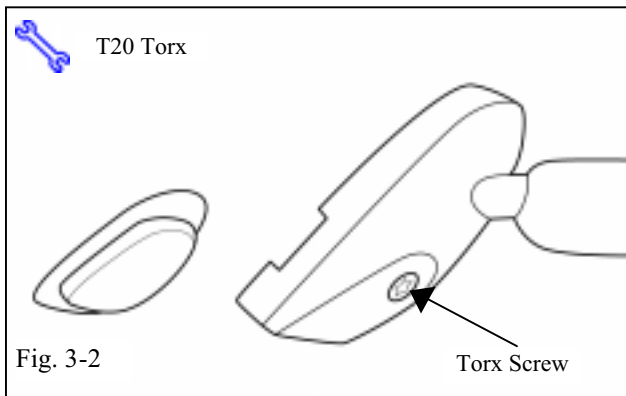

- (a) Plug wire harness 10-pin connector into the back of mirror. (Fig. 3-1)

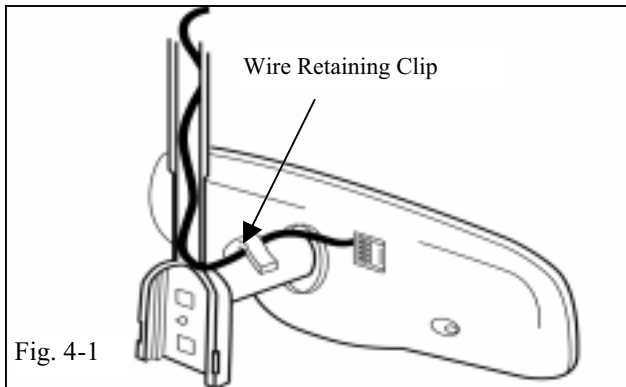

- (b) Slide the EC mirror onto the mounting button on windshield. (Fig. 3-2)
-  (c) Tighten the screw in the mirror mounting bracket with torque wrench to 1.75 N-m (15.5 lbf-in).

4. Wire Harness and Overhead Console Installation.



-  (a) Carefully pull down on the headliner and route wire harness from center area of headliner to driver side pillar.
- (b) Attach the wire retaining clip over the Routed wire harness. (Fig. 4-1)
 - (1) Slide the wire harness cover over the wire harness and extend to completely cover wire harness.
 - (2) Be sure the bottom of cover is securely mounted to base.

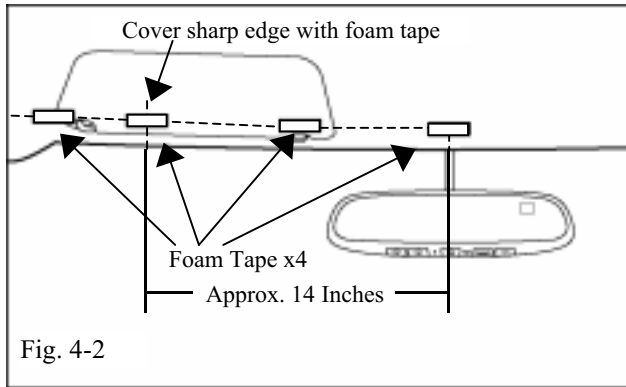

(c) Cover the sharp edge with foam tape. (Fig. 4-2)

(d) Secure wire harness to roof panel with three (3) remaining pieces of foam tape in locations shown. (Fig. 4-2)



(1) Use caution when applying foam tape to prevent creasing of headliner near grab handle.

(2) Before applying foam tape, be sure the mirror has full range of movement.

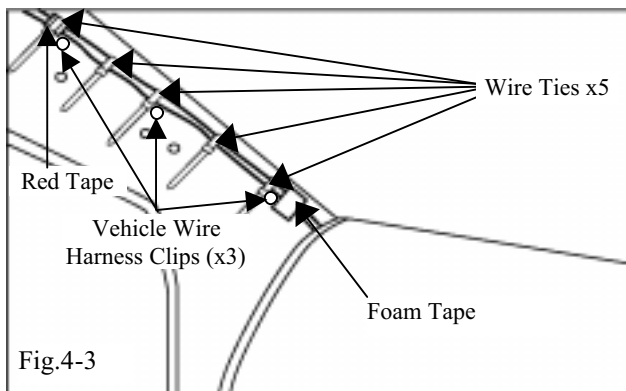

(e) Route wire harness down "A" pillar next to vehicle harness and loosely secure with five (5) wire ties to vehicle harness. (Fig. 4-3)

(1) Locate upper, middle and lower wire ties close to vehicle wire harness clips.

(2) Secure wire harness with foam tape. (Fig. 4-3)

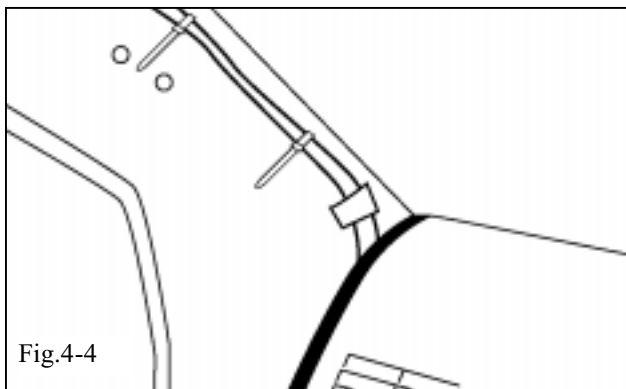

(f) Route wire harness between "A" pillar and dash, into instrument panel area as shown. (Fig. 4-4)

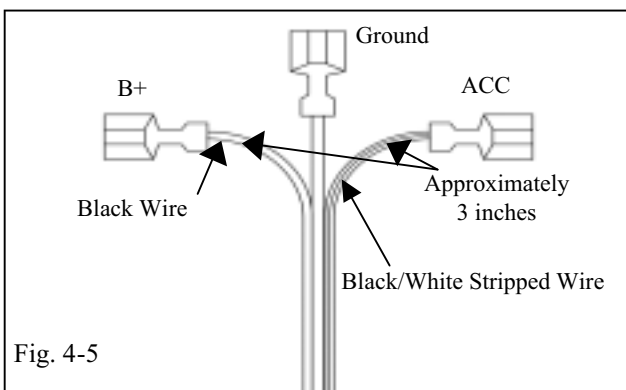

(g) Locate the B+ and ACC wires and pull them apart from mirror wire harness (approximately 3 inches). (Fig. 4-5)

(1) The B+ wire is the outside wire of the harness and opposite the ACC wire with the white stripe.

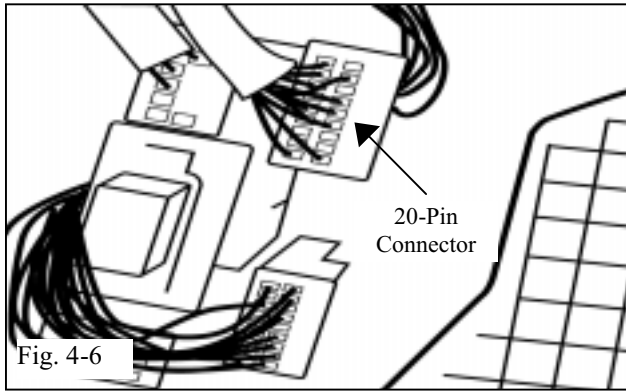

(h) Locate the 20-pin white connector in driverside cowl area. (Fig. 4-6)

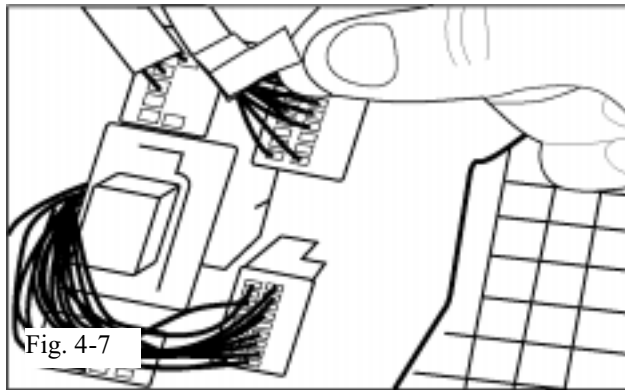

(i) Remove electrical tape and push back insulation to expose approximately one inch of wire bundle. (Fig. 4-7)

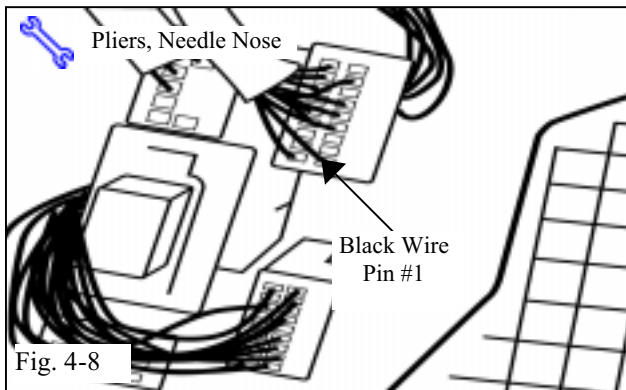

(j) Locate Black wire in 20-pin connector. (Pin #1) (Fig. 4-8)

- (1) Apply Red T-tap to the Black wire about one inch from the connector, with needle nose pliers.
- (2) Make sure T-tap halves are snapped together and secured.

(k) Plug the Black (B+) wire with the spade connector into the T-tap on the Black wire of the 20-pin connector.

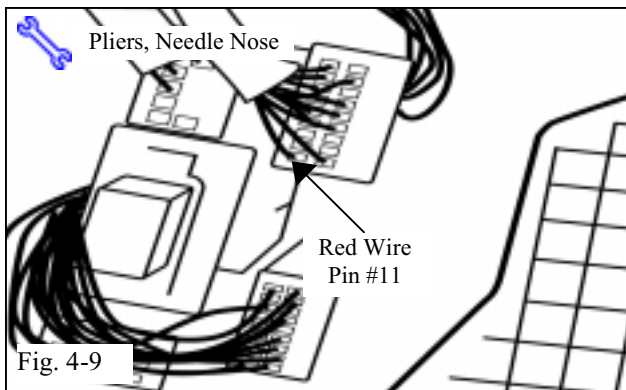

(l) Locate Red wire in 20-pin connector (Pin #11). (Fig. 4-9)

- (1) Apply Red T-tap to the Red wire about one inch from connector, with needle nose pliers.
- (2) Make sure T-tap halves are snapped together and secured.

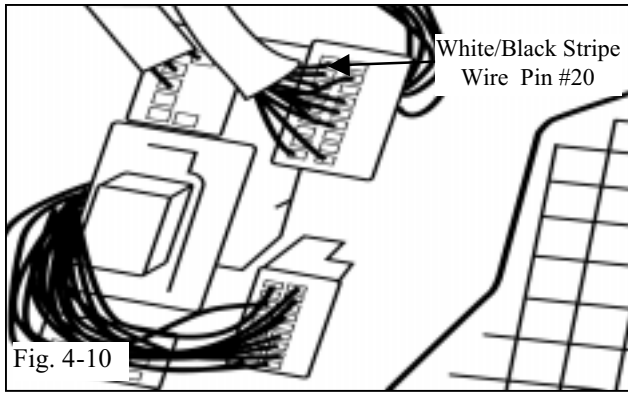

- (m) Plug the Black/White-Striped (ACC) wire with the spade connector into the T-tap on the Red wire of the 20-pin connector.
- (n) Locate White/Black striped wire in 20-pin connector. (Pin #20) (Fig. 4-10)
 - (1) Apply Blue T-tap to the White/Black striped wire about one inch from connector, with needle nose pliers.
 - (2) Make sure T-tap halves are snapped together and secured.
- (o) Plug the Black (Ground) wire with the spade connector into the T-tap on the White/Black-striped wire of the 20-pin connector.

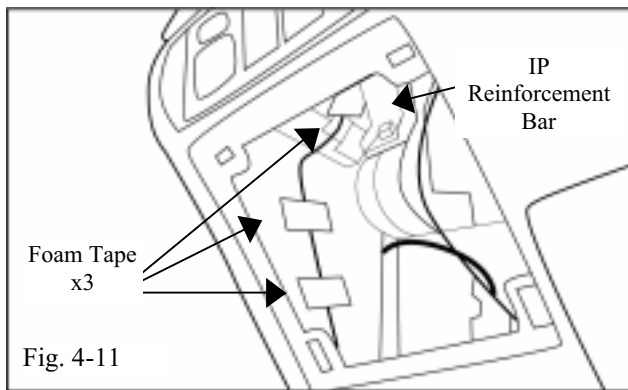

- (p) Tape wire harness in three (3) locations to inside dash panel in fuse box area (Fig 4-11)
 - (1) Keep wire harness away from IP reinforcement bar.

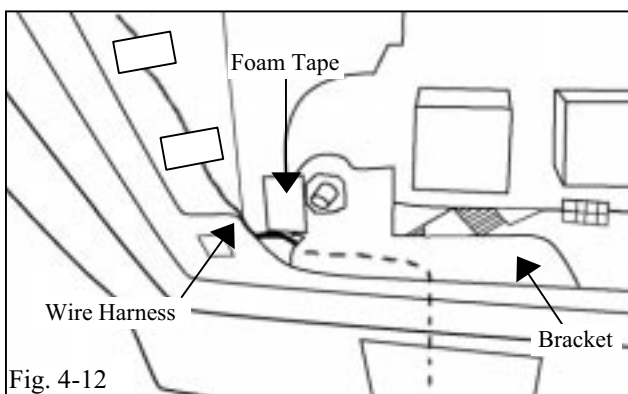

- (q) Place foam tape over sharp edge and route wire harness behind bracket. (Fig. 4-12)

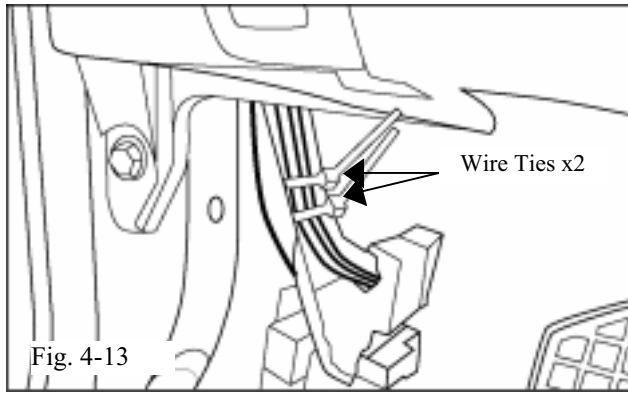

- (r) Bundle excess wire and secure wire harness with two (2) wire ties. (Fig 4-13)
- (s) Reinstall overhead console.

5. Reconnect Negative Battery Cable.

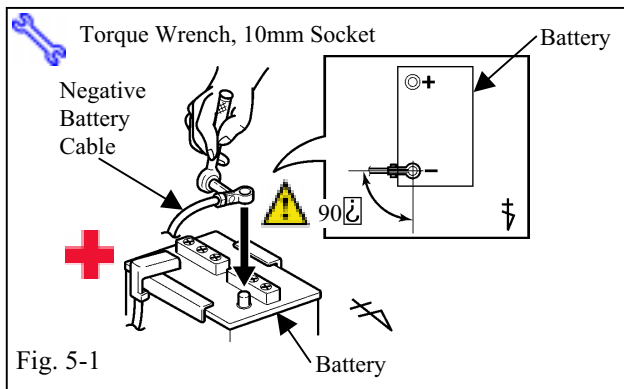

- (a) Reconnect the vehicle's negative battery cable. (Fig. 5-1)
 - (1) Position the negative terminal to the battery as shown (~90 degrees).
 - (2) Tighten the nut to 4.1 N-m (36 lbf-in).
 - (3) Do not touch the positive terminal with any tool when replacing the cable

6. Testing.

- (a) Turn ignition key to ON position.
- (b) Ambient Lighting Feature:
 - (1) Verify that the vehicle is in a dark area, so that colors may be checked.
 - (2) Press and hold the Map Light button. (Fig. 6-1). The initial mode will be bright white map lights.
 - (3) Continue to hold the Map Light button, to cycle through the ambient lighting options:-
 - Soft amber will appear after 3 seconds.
 - Soft blue will appear after 6 seconds.
 - Soft white will appear after 9 seconds.
 - Soft amber will appear again after 12 seconds.

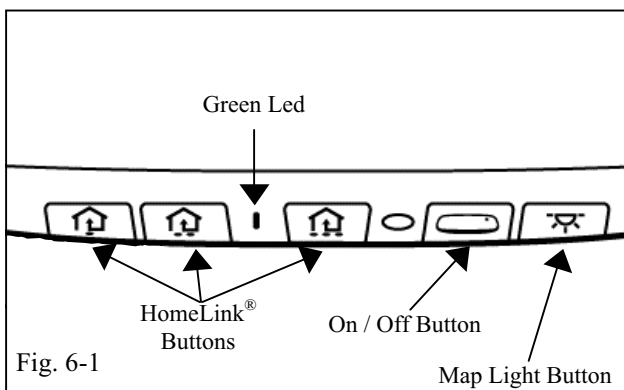

- (4) Light will turn off (after approximately 15 seconds). Release button during this step.
- (c) With the vehicle in a fairly well-lit area, perform the following:
- (d) HomeLink(R) Feature:
 - (1) Push in HomeLink(R) switches, one at a time. Verify that the LED Indicator light is red when each switch is pushed.
 - (2) Remove the ignition key.
 - (3) Push in HomeLink(R) switches, one at a time. Verify that the LED Indicator light is red when each switch is pushed.

HomeLink(R) and the HomeLink(R)house are registered trademarks of Johnson Controls, Inc.

NOTE: The owner of the vehicle will need to program HomeLink(R). See the HomeLink(R) programming instructions or visit the HomeLink(R) website at www.homelink.com.

- (e) Auto Dimming Feature:
 - (1) Reinsert ignition key and turn to ON position.
 - (2) To make sure the auto-dimming feature is on, verify that the green LED to the left of the center HomeLink(R) button is on. (Fig. 6-1). If it is not on, push the On / Off) button to turn the feature on.
 - (3) Cover the forward-looking light sensor located below the wire harness connection of the back of the mirror (a dark cloth or towel will work). (Fig. 6-2)
 - (4) In a few seconds, mirror will begin to darken (time may vary with ambient light level).

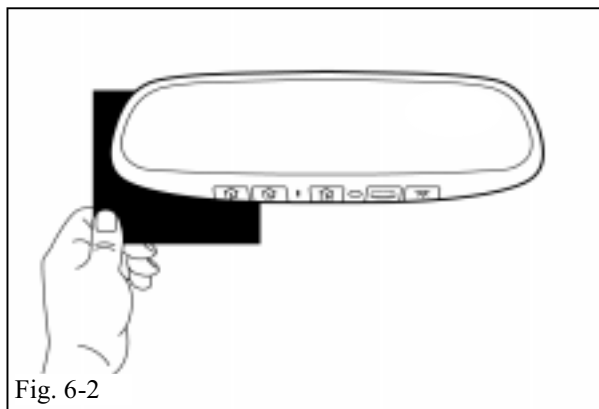

Fig. 6-2

(5) Remove the cover from the forward photocell and the mirror will begin to clear.

(6) Turn ignition key to OFF position.

7. Final Assembly.

(a) Reinstall driver side cowl cover.

(b) Reinstall driver side scuff plate.

(c) Reinstall fuse cover panel.

(d) Reinstall driver side "A" pillar trim.

(e) Reinstall driver side sun visor and clips.



(f) Place the operation instruction card in the vehicle glove box.

(g) Remove fingerprints, smudges, dirt, etc. from mirror and windshield with Household Windex.

(1) When cleaning with Household Windex, follow the manufacturer's directions. Do not allow cleaner to air dry.

(h) Verify each reinstalled component for proper fit and function.

8. For Accessory fitted after Pre Delivery Service Only.

- (a) Reset the power windows.
 - (1) Turn ignition key to ON position.
 - (2) Push down the power window switches of each door, and lower the windows halfway.
 - (3) Pull up the switches until the windows close and hold switches up for a further one (1) second (minimum.)
- (b) Reset the power moon roof.
 - (1) Push and hold moon roof switch to close side until moon roof closes. Hold for a further 2 seconds.
- (c) Reset the tailgate door.
 - (1) Push door lock control switch to the "unlock" side.
 - (2) Pull up tailgate door handle.

Checklist - these points **MUST** be checked to ensure a quality installation.

Check:

Look For:

Accessory Function Checks

Vehicle should be in a fairly well lit area.

- Turn ignition switch to ON.

Auto-dimming feature:

- Cover the forward-looking light sensor (located below the wire harness connection on the back of the mirror).

Mirror clears:

- Remove cover from photocell.

HomeLink(R) feature:

- Push in HomeLink(R) switches with key in AND out of the key slot.
- Push the On / Off button a second time and hold for 3 seconds.

Map lights feature:

- Push the Map Light button on the mirror.

Ambient lighting feature:

Vehicle should be in a fairly dark area if the ambient lighting colors cannot be seen.

- Push the Map Light button on the mirror.
- Push the Map Light button on the mirror again and hold until ambient feature is off.

- Operation Instruction Card
- HomeLink(R) Programming Instructions

Verify green LED is on. If it is not ON press On / Off button - confirm LED is ON.

Verify mirror darkens.

Mirror returns to clear state.

Verify LED indicators turns red.

Verify the visual display turns off.

Verify that map lights turn on.

Verify that white map lights turn on.

Colored ambient light should turn on, and cycle - amber - blue - white - amber  off.

Placed in the vehicle glove box.

Placed in the vehicle glove box

Checklist - these points **MUST** be checked to ensure a quality installation.

Check:

Look For:

Vehicle Function Checks

- Check dome light
- Check Moon Roof
- Check Power Windows
-  Check battery negative cable

Verify dome light functions properly.

Verify Moon Roof functions properly.

Verify Power Windows function properly.

Nut should be tightened to 4.1 N-m
(36 lbf-inch).